

Features

- 7" Food Industrial Panel PC
- Flat front panel touch screen
- Fanless design
- Intel Celeron N2930 Processor
- Onboard 4GB DDR 3L 1600 MHz
- Wide range DC 9~36V power input

Specifications

System	
CPU	Onboard Intel Celeron N2930 Processor (2M Cache, 1.83GHz)
System Chipset	SoC
Memory	Onboard 4GB DDR3L SDRAM

IO Port	
USB	2 x USB 3.0 type A
Serial / Parallel	1 x RS-232/422/485 DB-9, default RS-232(COM1) 1 x RS-232 DB-9(COM2)
LAN	2 x GbE LAN RJ-45
Audio	1 x Line Out
Power	1 x 3-pin DC Power input terminal 1 x 2-pin connector for power on/off button

Storage Space	
HDD/SSD	1 x MO-297 SSD space
Others	1 x internal SD slot onboard

Expansion	
Expansion Slot	1 x Internal Mini-PCIe slot full size on board

Display	Standard	High Brightness Optional
Display Type	7" TFT-LCD	7" TFT-LCD
Max. Resolution	800 x 480	800 x 480
Max. Color	262K	262K
Luminance (cd/m ²)	420	1000
View Angle	110(H) /140(V)	130(H) /140(V)
Contrast	400:1	400:1
Backlight Lifetime	40,000 hrs	50,000 hrs

Touch Screen	
Type	Projected Capacitive Touch (For P model) Glass (For G model)
Interface	USB
Light Transmission(%)	Over 90%

Power	
Power Input	DC 9~36V
Power Consumption	FABS-807P: 12W

Dimensions

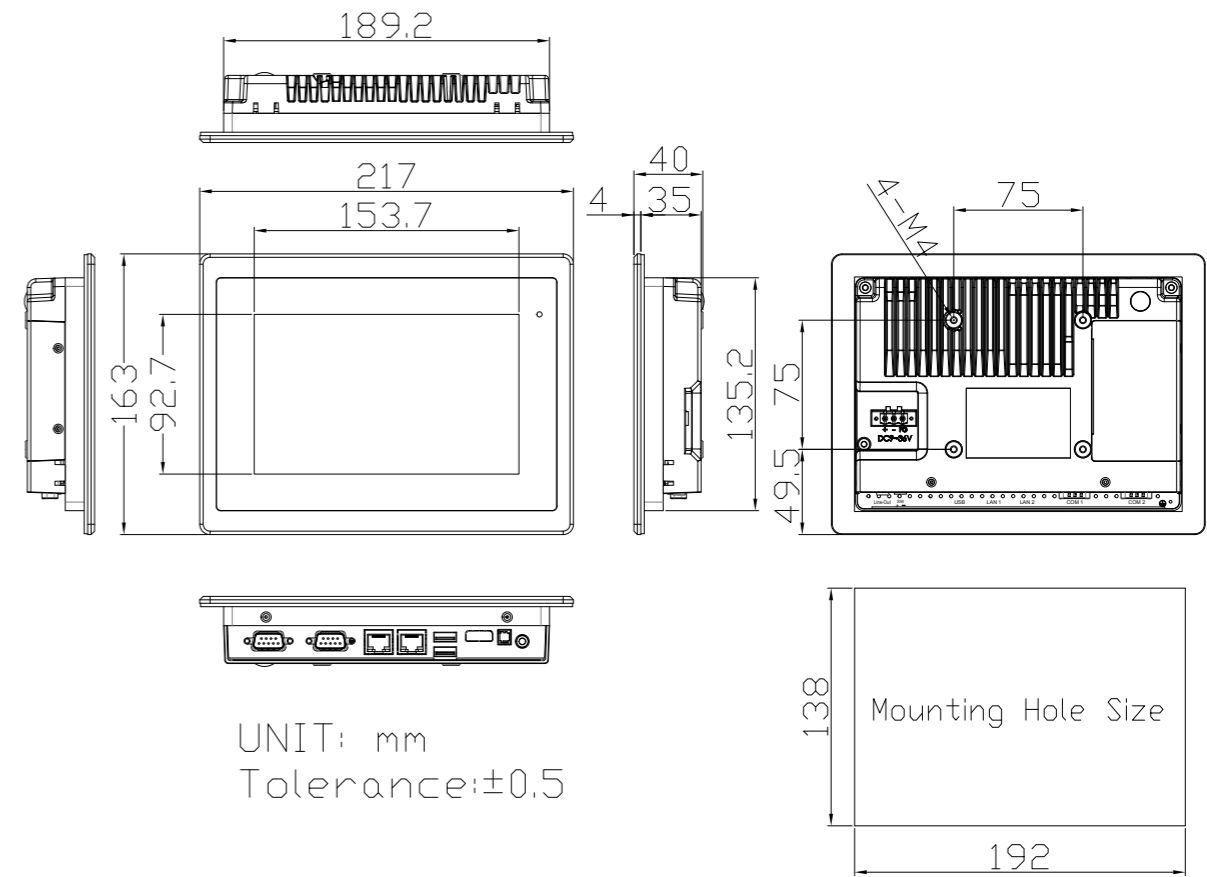

Mechanical	
Construction	304 Stainless steel front bezel (Default) 316 Stainless steel front bezel (Optional) Aluminum back cover
Mounting	Panel mount, VESA mount 75 x 75
IP Rating	Front Panel IP66/IP69K
Dimensions	217 x 163 x 40 mm
Net Weight	1.2 kg

Environmental	
Operating Temperature	0~50°C, -20~60°C (option)
Storage Temperature	-20~60°C
Storage Humidity	10 to 90% @ 40°C, non- condensing
Certificate	CE / FCC Class A/EN 1672-2

Operating System Support	
WEC 7, Windows Embedded 7, Windows Embedded 8.1, Windows 10 IoT ENT LTSB	

Ordering Information	
FABS-807P (Barebone)	7" WVGA fanless HMI barebone with Celeron N2930(1.83.GHz) CPU, 4GB DDR3L RAM, Projected Capacitive touch, 9~36VDC input with adapter, Stainless front bezel and Aluminum chassis.
FABS-807G (Barebone)	7" WVGA fanless HMI barebone with Celeron N2930 (1.83.GHz) CPU, 4GB DDR3L RAM, Protection Glass, 9~36V DC input with adapter, Stainless front bezel and Aluminum chassis.