

Features

- 19" Food Industrial Panel PC
- Flat front panel touch screen
- Fanless design
- 6th/7th Gen. Intel Core i3/i5/i7 Processors
- DDR4 SO-DIMM Socket
- Wide range DC 9~36V power input

Specifications

System	
CPU	6th/7th Gen. Intel Core i3/i5/i7 Processors
System Chipset	SoC
Memory	DDR4 SO-DIMM Socket

IO Port	
USB	2 x USB 3.0 type A
Serial / Parallel	1 x RS-232/422/485 DB-9, default RS-232(COM1) 1 x RS-232 DB-9(COM2)
LAN	2 x GbE LAN RJ-45
Audio	1 x Line Out
Power	1 x 3-pin DC Power input terminal 1 x 2-pin connector for power on/off button

Storage Space	
HDD/SSD	1 x 2.5" SATA HDD space (Easily Accessible)

Expansion	
Expansion Slot	1 x Internal Mini-PCIe slot full size on board

Display	Standard	High Brightness Optional
Display Type	19" TFT-LCD	19" TFT-LCD
Max. Resolution	1280 x 1024	1280 x 1024
Max. Color	16.7M	16.7M
Luminance (cd/m ²)	350	900
View Angle	170(H)/160(V)	170(H)/165(V)
Contrast	1000:1	1000:1
Backlight Lifetime	50,000 hrs	50,000 hrs

Touch Screen	
Type	Projected Capacitive Touch (For P model) Resistive Touch(For R model) Glass (For G model)
Interface	USB
Light Transmission(%)	Resistive Touch : 80% Projected Capacitive : 90%

Power	
Power Input	DC 9~36V
Power Consumption	FABS-919AP: 60W

Dimensions

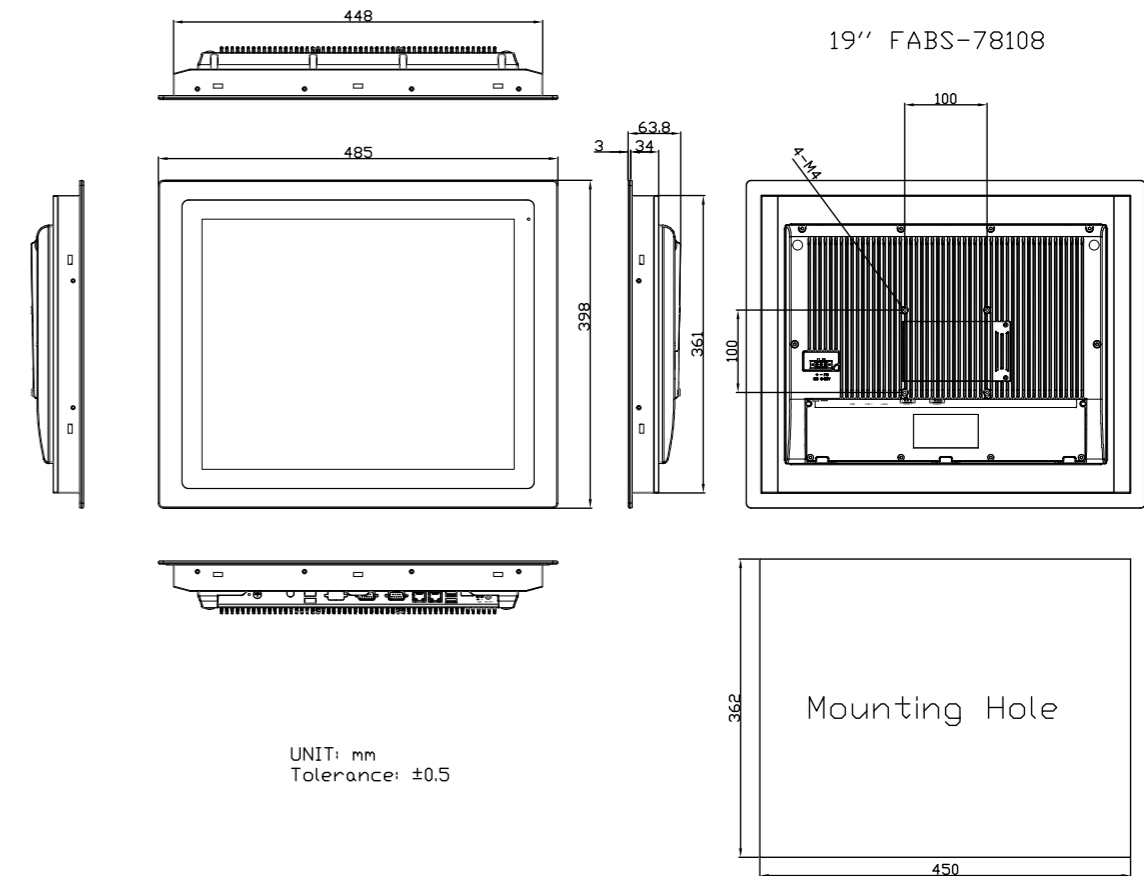

Mechanical	
Construction	304 Stainless steel front bezel (Default) 316 Stainless steel front bezel (Optional) Aluminum back cover
Mounting	Panel mount, VESA mount 100 x 100
IP Rating	Front Panel IP66/IP69K
Dimensions	485 x 398 x 63.8 mm
Net Weight	5.9 kg

Environmental	
Operating Temperature	0~50°C
Storage Temperature	-30~70°C
Storage Humidity	10 to 90% @ 40°C, non-condensing
Certificate	CE / FCC Class A EN 1672-2 (Exclude R model)

Operating System Support	
Windows 10 IoT ENT LTSB	

Ordering Information	
FABS-919AP (Barebone)	19" SXGA fanless HMI barebone with Intel 6th Corei3-6100U CPU, 1 x DDR4 SO-DIMM Socket, Projected Capacitive touch, 9~36V DC input with adapter, Stainless steel front bezel and Aluminum chassis.
FABS-919AR (Barebone)	19" SXGA fanless HMI barebone with Intel 6th Corei3-6100U CPU, 1 x DDR4 SO-DIMM Socket, Resistive touch, 9~36V DC input with adapter, Stainless steel front bezel and Aluminum chassis.
FABS-919AG (Barebone)	19" SXGA fanless HMI barebone with Intel 6th Corei3-6100U CPU, 1 x DDR4 SO-DIMM Socket, Protection glass, 9~36V DC input with adapter, Stainless steel front bezel and Aluminum chassis.

